

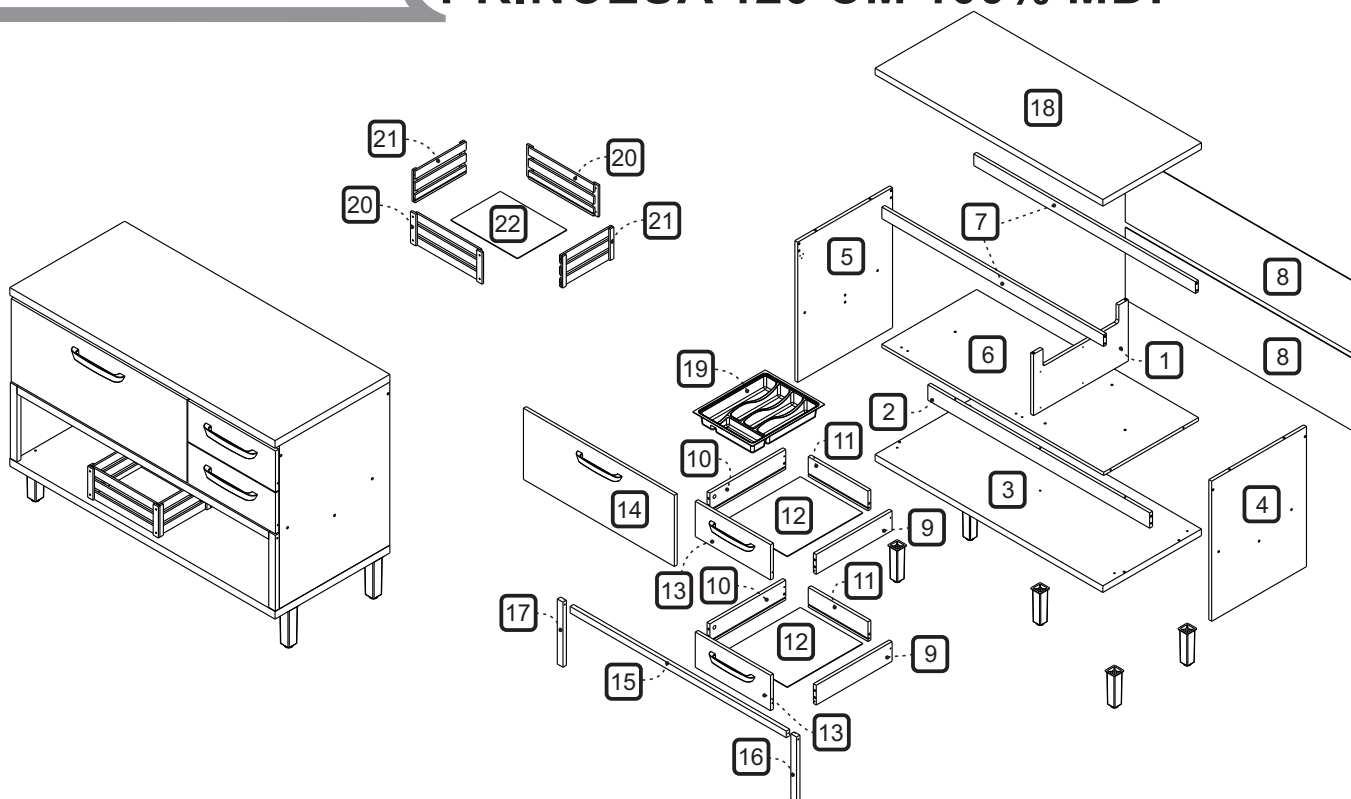

MANUAL DE MONTAGEM

**BALCÃO 1 PORTA 2 GAVETAS COM CAIXA ORGANIZADORA NESHER PRINCESA 120 CM 100% MDF**



**DIMENSÕES DOS ESPAÇOS INTERNOS (MEDIDAS EM MILÍMETRO)**

**DIMENSÕES MÁXIMAS DO PRODUTO MONTADO**

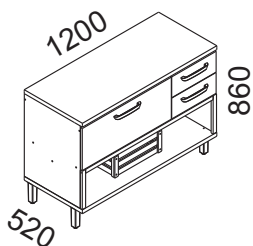





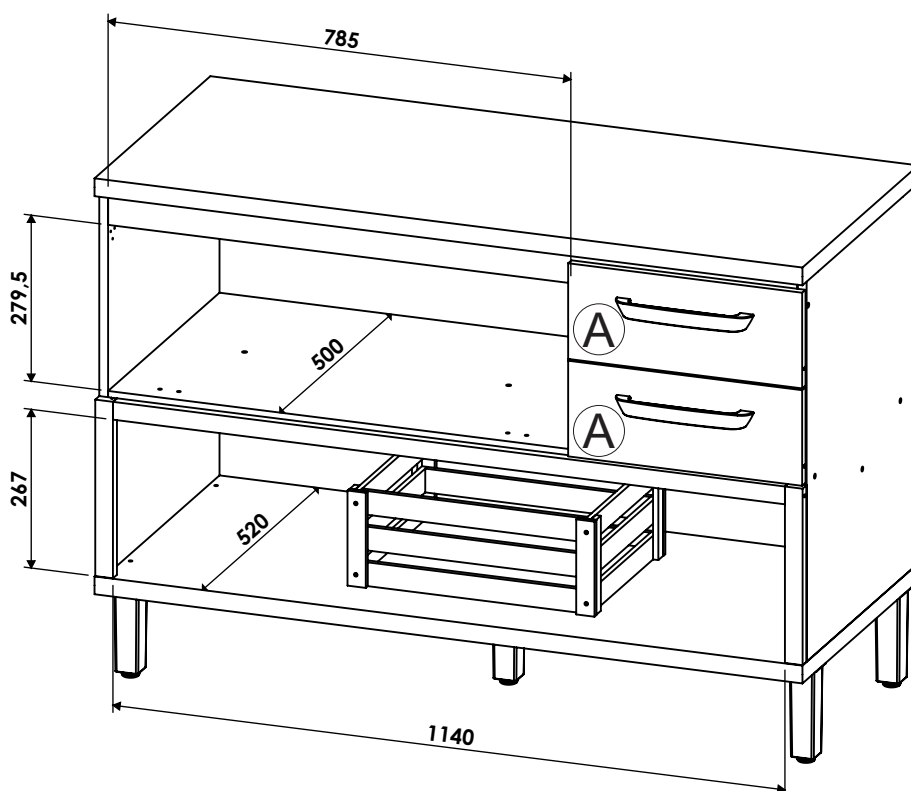

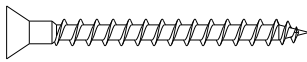
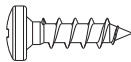

**ESPAÇO INTERNO DAS GAVETAS (largura x altura x profundidade)**

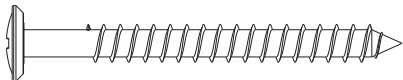
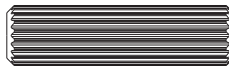
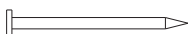
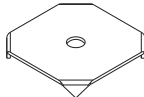
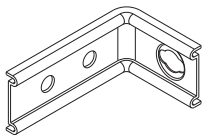
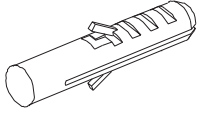
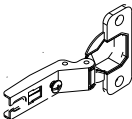
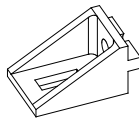
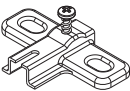
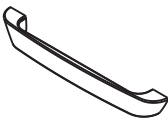

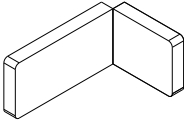



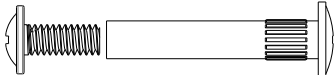
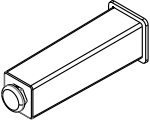
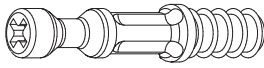
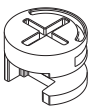
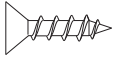
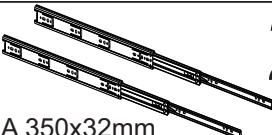

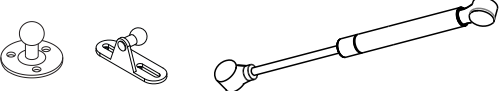
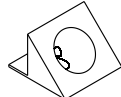
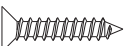
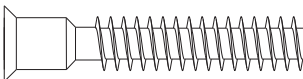
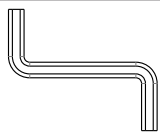
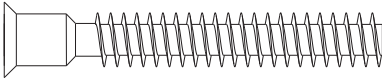
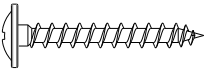
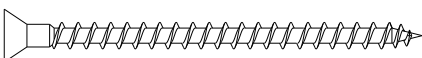



Ⓐ 315 x 78 x 385 mm

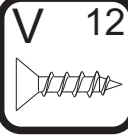

CÓDIGO	DESCRIÇÃO	QTDE	COMP	LARG	ESP
1	DIVISÃO	1	280	500	15
2	TRAVESSA SUSTENTAÇÃO	1	1170	70	15
3	BASE	1	1201	520	30
4	LATERAL DIREITA	1	640	500	15
5	LATERAL ESQUERDA	1	640	500	15
6	PRATELEIRA	1	1170	500	15
7	TRAVESSA SUPERIOR	2	1169	53	15
8	FUNDO TRASEIRO 1195x330	2	1195	330	2,5
9	LATERAL GAVETA DIR	2	400	90	15
10	LATERAL GAVETA ESQ	2	400	90	15
11	TRASEIRO GAVETA MENOR	2	315	90	15
12	FUNDO GAVETA 329 X 398	2	329	398	2,5
13	FRENTE GAVETA	2	397	161	15
14	PORTA BASCULANTE	1	796	325	15
15	MOLDURA SUPERIOR	1	1140	30	18
16	MOLDURA LATERAL DIR	1	297	30	18
17	MOLDURA LATERAL ESQ	1	297	30	18
18	BANCADA	1	1201	520	30
19	DIVISOR DE TALHERES	1	384	314	60
20	LATERAL MAIOR MONTADA - CAIXA ORGANIZADORA	2	419	160	18
21	LATERAL MENOR MONTADA - CAIXA ORGANIZADORA	2	300	160	18
22	FUNDO 390 X 290 - CAIXA ORGANIZADORA	1	390	290	2,5

CÓDIGO/DESCRIÇÃO	QUANTIDADE	CÓDIGO/DESCRIÇÃO	QUANTIDADE
<b>A</b>  PARAFUSO 3,5x40mm CABEÇA CHATA	<b>12</b>	<b>B</b>  PARAFUSO 4x14mm CABEÇA PANELA	<b>54</b>
<b>C</b>  TAMPA MINIFIX	<b>4</b>	<b>D</b>  PARAFUSO DE UNIÃO 17mm	<b>4</b>
<b>E</b>  PARAFUSO 5x50mm CABEÇA FLANGEADA	<b>11</b>	<b>F</b>  CAVILHA 8x30mm	<b>20</b>
<b>G</b>  PREGO 10x10 COM CABEÇA	<b>44</b>	<b>H</b>  FIXADOR FUNDO TRASEIRO METÁLICO	<b>12</b>
<b>I</b>  CANTONEIRA METALICA PARA FIXAÇÃO NA PAREDE	<b>6</b>	<b>J</b>  BUCHA DE PAREDE DE 8mm	<b>6</b>
<b>K</b>  DOBRADIÇA ALTA CANECO 35mm	<b>2</b>	<b>L</b>  SUPORTE ANGULAR	<b>8</b>
<b>M</b>  CALÇO PARA DOBRADIÇA 35mm - 5mm	<b>2</b>	<b>N</b>  PUXADOR FURAÇÃO 192mm	<b>3</b>
<b>O</b>  TAPA FURO ADESIVO 12mm	<b>18</b>	<b>P</b>  CAPA PLÁSTICA PARA CANTONEIRA	<b>6</b>

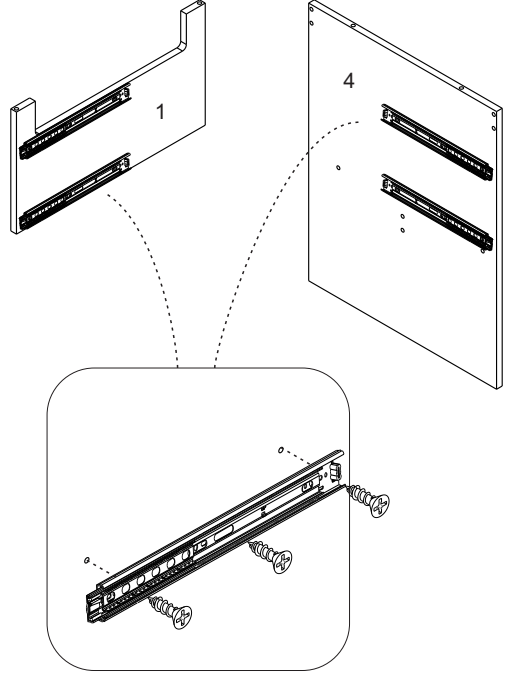
<b>Q</b> BATENTE DE SILICONE 	<b>6</b>	<b>R</b> PARAFUSO UNIAO DE MÓDULOS 28MM 	<b>3</b>
<b>S</b> PÉS 	<b>5</b>	<b>T</b> PARAFUSO MINIFIX 	<b>4</b>
<b>U</b> TAMBOR MINIFIX 	<b>4</b>	<b>V</b> PARAFUSO 3,5x14mm CABEÇA CHATA 	<b>32</b>
<b>W</b> PAR CORREDIÇA TELESCÓPICA 350x32mm 	<b>2</b>	<b>X</b> CANTONEIRA METÁLICA DE FIXAÇÃO 	<b>8</b>
<b>Y</b> PISTÃO A GÁS 60N INVERSO 	<b>1</b>	<b>Z</b> DISPOSITIVO FIXADOR DE FUNDO 	<b>8</b>
<b>A1</b> PARAFUSO 3 x 16 CABEÇA CHATA 	<b>8</b>	<b>A2</b> PARAFUSO 7x40mm CABEÇA CHATA 	<b>15</b>
<b>A3</b> CHAVE ZETA 	<b>1</b>	<b>A4</b> PARAFUSO 7x50mm CABEÇA CHATA 	<b>4</b>
<b>A5</b> PARAFUSO CABEÇA FLANGEADA 3,5 X 25mm 	<b>6</b>	<b>A6</b> PARAFUSO 3,5X50mm CABEÇA CHATA 	<b>2</b>

<p><b>Ferramentas para montagem e instalação</b></p> <div style="display: flex; flex-wrap: wrap;"> <div style="text-align: center; margin: 5px;"> PARAFUSADEIRA</div> <div style="text-align: center; margin: 5px;"> FURADEIRA</div> <div style="text-align: center; margin: 5px;"> NÍVEL</div> <div style="text-align: center; margin: 5px;"> TRENA</div> <div style="text-align: center; margin: 5px;"> MARTELO</div> <div style="text-align: center; margin: 5px;"> CHAVE PHILIPS E FENDA</div> </div> <p><b>Montagem</b> </p> <p><b>Instalação</b> </p>	<p><b>PASSO 2</b></p> <div style="display: flex; align-items: center;"> <div style="border: 1px solid black; padding: 5px; margin-right: 10px;"><b>V</b> 12 </div> <div style="border: 1px solid black; padding: 5px; margin-right: 10px;"><b>W</b> 4 </div> </div> <p>1 - Fixar as corredeiras W nas marcações da divisão 1 e da lateral 4, utilizando os parafusos V (3,5x14mm)</p> 
<p><b>PASSO 1</b></p> <div style="display: flex; align-items: center;"> <div style="border: 1px solid black; padding: 5px; margin-right: 10px;"><b>W</b> 4 </div> </div> <p>1 - Para montagem das corredeiras nas gavetas é necessário primeiramente separar o conjunto</p> <p>2 - Levante a trava indicada no desenho abaixo e puxe a peça até separá-las totalmente</p> 